

## The RF Line NPN Silicon Power Transistors

... designed for 12.5 volt large-signal power amplifiers in commercial and industrial equipment.

- High Common Emitter Power Gain
- Specified 12.5 V, 175 MHz Performance
  - Output Power = 30 Watts
  - Power Gain = 10 dB
  - Efficiency = 60%
- Diffused Emitter Resistor Ballasting
- Characterized to 220 MHz
- Load Mismatch at High Line and Overdrive Conditions

**MRF1946**  
**MRF1946A**

**30 W, 136–220 MHz**  
**RF POWER**  
**TRANSISTORS**  
**NPN SILICON**

### MAXIMUM RATINGS

Rating	Symbol	Value	Unit
Collector–Emitter Voltage	$V_{CEO}$	16	Vdc
Collector–Base Voltage	$V_{CBO}$	36	Vdc
Emitter–Base Voltage	$V_{EBO}$	4.0	Vdc
Collector Current — Continuous	$I_C$	8.0	Adc
Total Device Dissipation @ $T_A = 25^\circ\text{C}$ Derate above $25^\circ\text{C}$	$P_D$	100 0.57	Watts W/ $^\circ\text{C}$
Storage Temperature Range	$T_{stg}$	-65 to +150	$^\circ\text{C}$
Junction Temperature	$T_J$	200	$^\circ\text{C}$

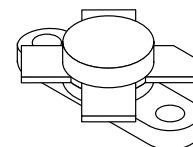

**CASE 211-07, STYLE 1**  
**MRF1946**

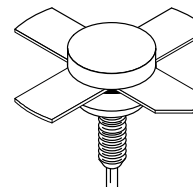

**CASE 145A-09, STYLE 1**  
**MRF1946A**

### THERMAL CHARACTERISTICS

Characteristic	Symbol	Max	Unit
Thermal Resistance, Junction to Case	$R_{\theta JC}$	1.75	$^\circ\text{C}/\text{W}$

### ELECTRICAL CHARACTERISTICS ( $T_C = 25^\circ\text{C}$ unless otherwise noted.)

Characteristic	Symbol	Min	Typ	Max	Unit
----------------	--------	-----	-----	-----	------

### OFF CHARACTERISTICS

Collector–Emitter Breakdown Voltage ( $I_C = 25 \text{ mAdc}$ , $I_B = 0$ )	$V_{(BR)CEO}$	16	—	—	Vdc
Collector–Emitter Breakdown Voltage ( $I_C = 25 \text{ mAdc}$ , $V_{BE} = 0$ )	$V_{(BR)CES}$	36	—	—	Vdc
Emitter–Base Breakdown Voltage ( $I_E = 5.0 \text{ mAdc}$ , $I_C = 0$ )	$V_{(BR)EBO}$	4.0	—	—	Vdc
Collector Cutoff Current ( $V_{CE} = 15 \text{ Vdc}$ , $V_{BE} = 0$ , $T_C = 25^\circ\text{C}$ )	$I_{CES}$	—	—	5.0	mAdc

### ON CHARACTERISTICS

DC Current Gain ( $I_C = 1.0 \text{ Adc}$ , $V_{CE} = 5.0 \text{ Vdc}$ )	$h_{FE}$	40	75	150	—
---	----------	----	----	-----	---

(continued)

**ELECTRICAL CHARACTERISTICS — continued** ( $T_C = 25^\circ\text{C}$  unless otherwise noted.)

Characteristic	Symbol	Min	Typ	Max	Unit
<b>DYNAMIC CHARACTERISTICS</b>					
Output Capacitance ( $V_{CB} = 15\text{ Vdc}$ , $I_E = 0$ , $f = 1.0\text{ MHz}$ )	$C_{ob}$	—	75	100	pF
<b>FUNCTIONAL TESTS</b>					
Common-Emitter Amplifier Power Gain ( $V_{CC} = 12.5\text{ Vdc}$ , $P_{out} = 30\text{ W}$ , $f = 175\text{ MHz}$ )	$G_{pe}$	10	11	—	dB
Collector Efficiency ( $V_{CC} = 12.5\text{ Vdc}$ , $P_{out} = 30\text{ W}$ , $f = 175\text{ MHz}$ )	$\eta$	60	70	—	%
Load Mismatch ( $V_{CC} = 15.5\text{ Vdc}$ , $P_{in} = 2.0\text{ dB Overdrive}$ , Load VSWR = 30:1)	$\psi$	No Degradation in Power Output			

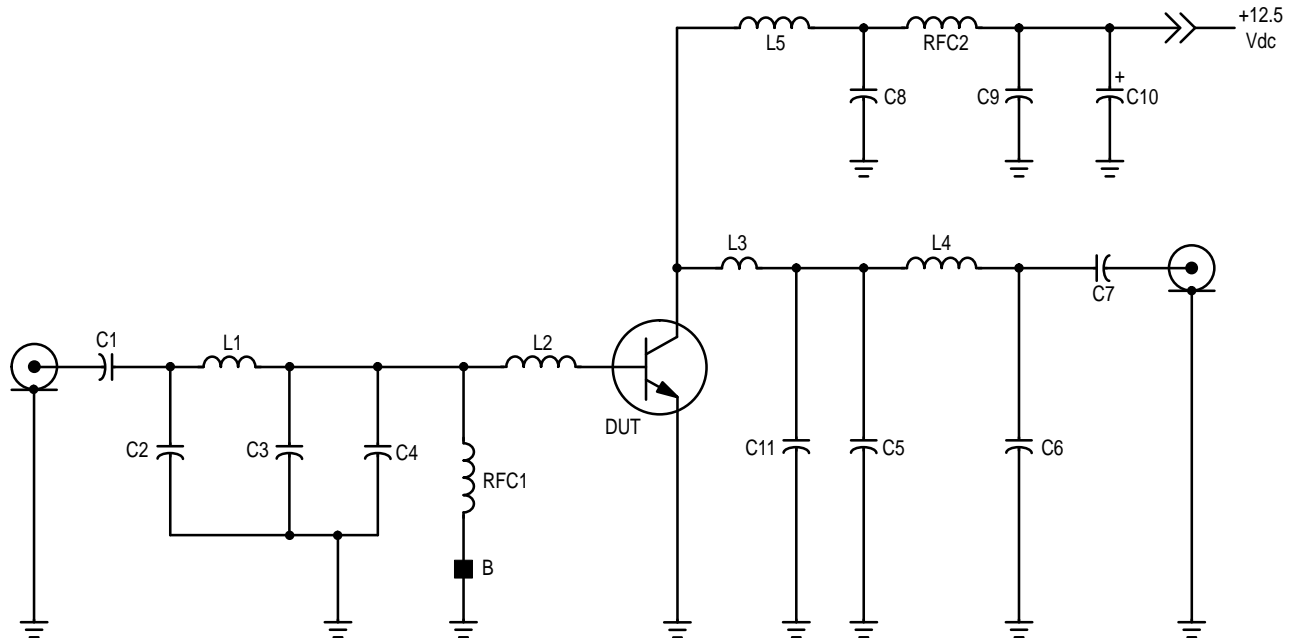

- C1 — 56 pF Mini-Unelco, 3HS0006-56
- C2 — 47 pF Mini-Unelco, 3HS0006-47
- C3, C4 — 180 pF Chip Cap, ATC 100B181JC500
- C5 — 150 pF Unelco, J101-150
- C6 — 39 pF Mini-Unelco, 3HS0006-39
- C7, C8 — 1000 pF Chip Cap, ATC 100B102JC50
- C9 — 0.1  $\mu\text{F}$  Ceramic Capacitor
- C10 — 10  $\mu\text{F}$ , 25 V Electrolytic Capacitor
- C11 — 56 pF Mini-Unelco, 3HS0006-56

- L1 — 2 Turns #18 AWG, 0.125" ID
- L2, L3 — Circuit Board and Mounting Pad Inductance
- L4 — 3 Turns #18 AWG, 0.125" ID
- L5 — 6 Turns #16 Enameled, 0.250" ID
- RFC1 — 0.15  $\mu\text{H}$  Molded Choke w/Ferrite Bead
- RFC2 — Ferrite Choke, Fair Rite VK200-4B
- Board Material — 1/32, Glass Teflon, 1 oz. Cu Plating
- Bead — Ferroxcube

**Figure 1. Broadband Test Circuit Schematic**

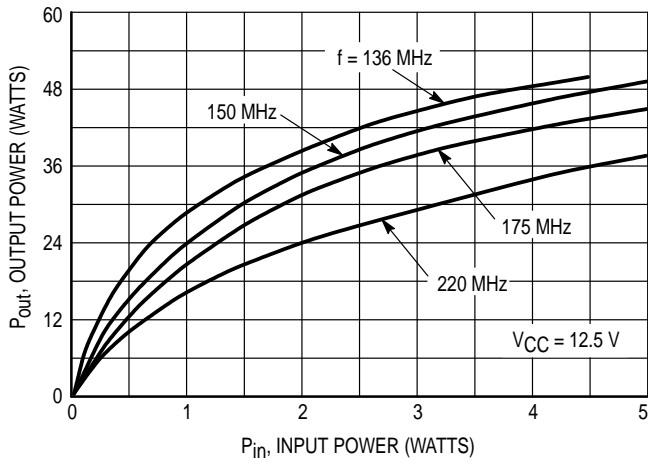

Figure 2. Output Power versus Input Power

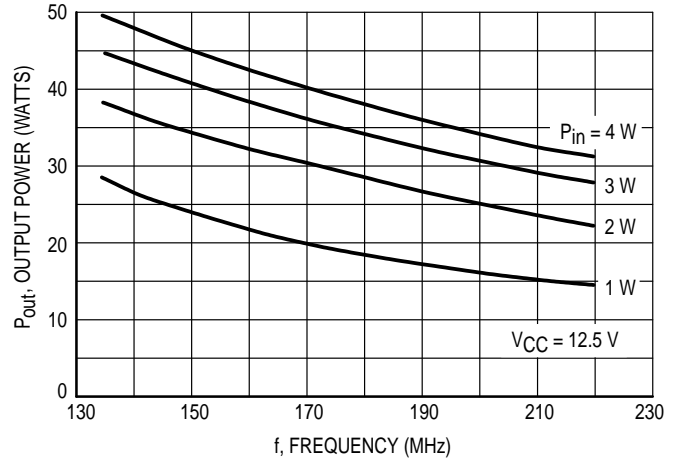

Figure 3. Output Power versus Frequency

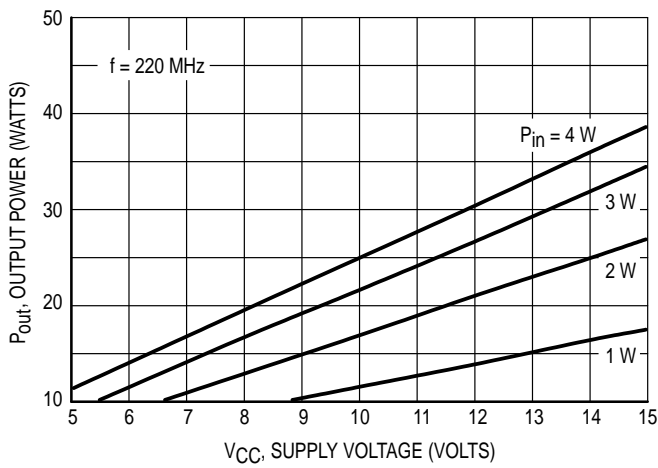

Figure 4. Output Power versus Supply Voltage

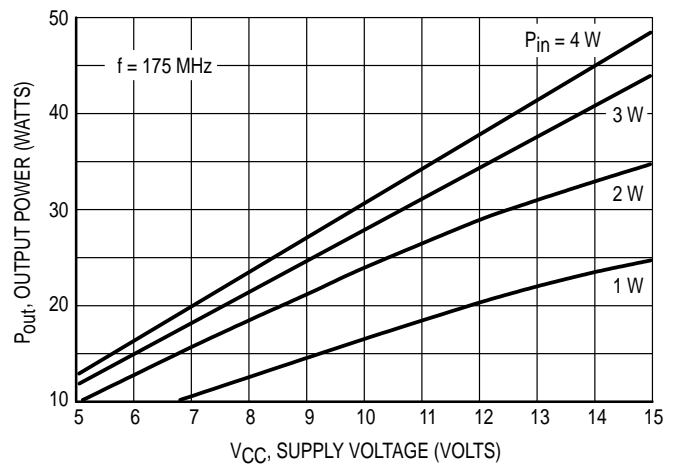

Figure 5. Output Power versus Supply Voltage

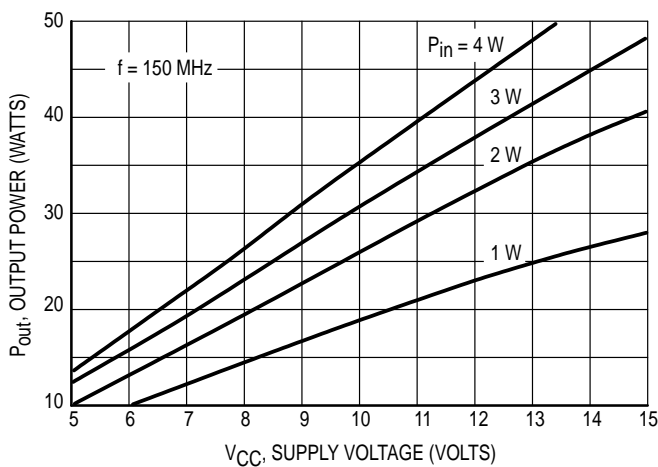

Figure 6. Output Power versus Supply Voltage

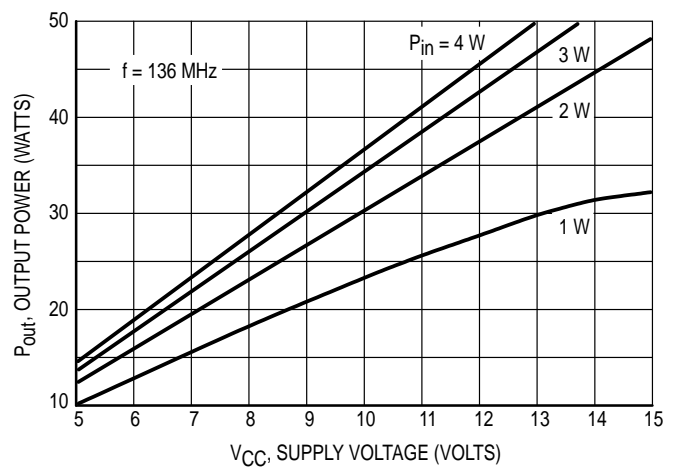

Figure 7. Output Power versus Supply Voltage

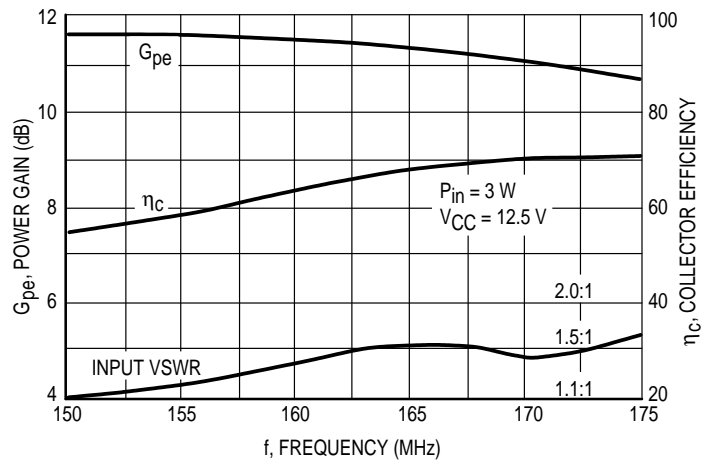
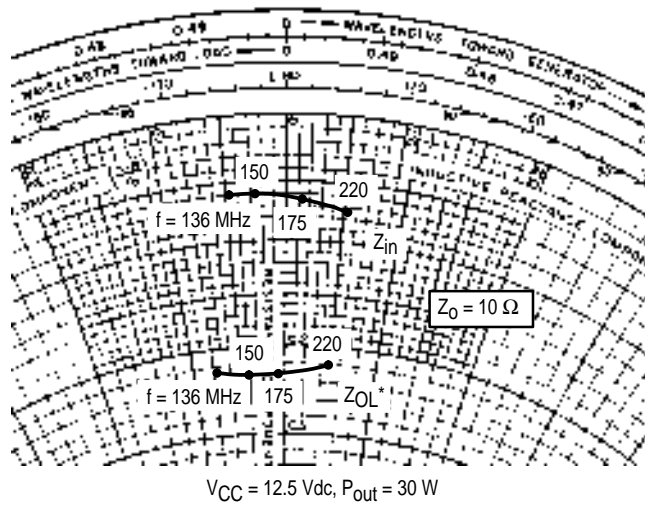

Figure 8. Typical Performance in a Broadband Circuit



$V_{CC} = 12.5 \text{ Vdc}, P_{out} = 30 \text{ W}$

f MHz	Z <sub>in</sub> Ohms	Z <sub>OL</sub> <sup>*</sup> Ohms
136	0.60 - j0.48	2.22 - j0.74
150	0.63 - j0.26	2.30 - j0.40
175	0.62 + j0.13	2.35 - j0.04
220	0.73 + j0.57	2.20 + j0.43

Z<sub>OL</sub><sup>\*</sup> = Conjugate of the optimum load impedance into which the device output operates at a given output power, voltage and frequency.

Figure 9. Series Equivalent Input and Output Impedance

## PACKAGE DIMENSIONS

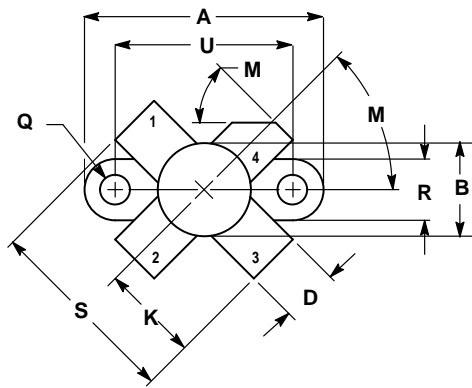

- NOTES:  
 1. DIMENSIONING AND TOLERANCING PER ANSI Y14.5M, 1982.  
 2. CONTROLLING DIMENSION: INCH.

DIM	INCHES		MILLIMETERS	
	MIN	MAX	MIN	MAX
A	0.960	0.990	24.39	25.14
B	0.370	0.390	9.40	9.90
C	0.229	0.281	5.82	7.13
D	0.215	0.235	5.47	5.96
E	0.085	0.105	2.16	2.66
H	0.150	0.108	3.81	4.57
J	0.004	0.006	0.11	0.15
K	0.395	0.405	10.04	10.28
M	40°	50°	40°	50°
Q	0.113	0.130	2.88	3.30
R	0.245	0.255	6.23	6.47
S	0.790	0.810	20.07	20.57
U	0.720	0.730	18.29	18.54

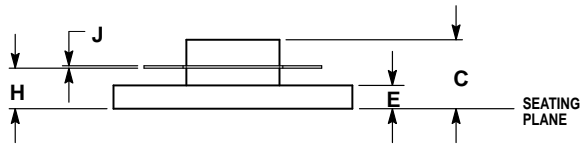

- STYLE 1:  
 PIN 1. EMITTER  
 2. BASE  
 3. EMITTER  
 4. COLLECTOR

**CASE 211-07  
 ISSUE N  
 MRF1946**

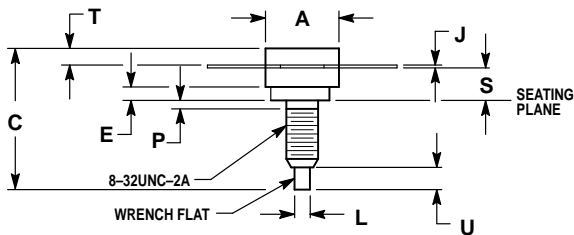

- NOTES:  
 1. DIMENSIONING AND TOLERANCING PER ANSI Y14.5M, 1982.  
 2. CONTROLLING DIMENSION: INCH.

DIM	INCHES		MILLIMETERS	
	MIN	MAX	MIN	MAX
A	0.370	0.385	9.40	9.78
B	0.320	0.330	8.13	8.38
C	0.670	0.790	17.02	20.07
D	0.215	0.235	5.46	5.97
E	0.070	—	1.78	—
J	0.003	0.007	0.08	0.18
K	0.490	—	12.45	—
L	0.055	0.070	1.40	1.78
M	45°NOM	—	45°NOM	—
P	—	0.050	—	1.27
R	0.299	0.307	7.59	7.80
S	0.158	0.178	4.01	4.52
T	0.083	0.100	2.11	2.54
U	0.098	0.132	2.49	3.35

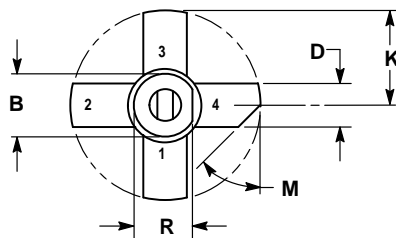

- STYLE 1:  
 PIN 1. EMITTER  
 2. BASE  
 3. EMITTER  
 4. COLLECTOR

**CASE 145A-09  
 ISSUE M  
 MRF1946A**

Motorola reserves the right to make changes without further notice to any products herein. Motorola makes no warranty, representation or guarantee regarding the suitability of its products for any particular purpose, nor does Motorola assume any liability arising out of the application or use of any product or circuit, and specifically disclaims any and all liability, including without limitation consequential or incidental damages. "Typical" parameters can and do vary in different applications. All operating parameters, including "Typicals" must be validated for each customer application by customer's technical experts. Motorola does not convey any license under its patent rights nor the rights of others. Motorola products are not designed, intended, or authorized for use as components in systems intended for surgical implant into the body, or other applications intended to support or sustain life, or for any other application in which the failure of the Motorola product could create a situation where personal injury or death may occur. Should Buyer purchase or use Motorola products for any such unintended or unauthorized application, Buyer shall indemnify and hold Motorola and its officers, employees, subsidiaries, affiliates, and distributors harmless against all claims, costs, damages, and expenses, and reasonable attorney fees arising out of, directly or indirectly, any claim of personal injury or death associated with such unintended or unauthorized use, even if such claim alleges that Motorola was negligent regarding the design or manufacture of the part. Motorola and  are registered trademarks of Motorola, Inc. Motorola, Inc. is an Equal Opportunity/Affirmative Action Employer.

**How to reach us:**

**USA / EUROPE:** Motorola Literature Distribution;  
P.O. Box 20912; Phoenix, Arizona 85036. 1-800-441-2447

**JAPAN:** Nippon Motorola Ltd.; Tatsumi-SPD-JLDC, Toshikatsu Otsuki,  
6F Seibu-Butsuryu-Center, 3-14-2 Tatsumi Koto-Ku, Tokyo 135, Japan. 03-3521-8315

**MFAX:** RMFAX0@email.sps.mot.com - TOUCHTONE (602) 244-6609  
**INTERNET:** <http://Design-NET.com>

**HONG KONG:** Motorola Semiconductors H.K. Ltd.; 8B Tai Ping Industrial Park,  
51 Ting Kok Road, Tai Po, N.T., Hong Kong. 852-26629298



MRF1946/D

